

VOLUME (l)
VOLUMEN (l)

MAX. LOAD (kg)
MAX. BELASTUNG (kg)

FLOOR LOAD (kg/m²)
BODENBELASTUNG (kg/m²)

285

445

310

- - Spot for el. cable 3×2.5mm², length approx. 1m
- - Platz Stromkabel 3 × 2,5 mm², Länge cca. 1 m
- - Spot for el. cable 1×6mm² for earthing, length approx. 1.5m
- - Platz Stromkabel 1 × 6 mm² für Erdung, Länge cca. 1,5 m

- ⊠ - Connection of hot and cold water 1/2" min 0.2Mpa, max 0.4Mpa
- ⊠ - Anschluss Warm- und Kaltwasser 1/2" min 0,2 Mpa, max 0,4 Mpa

- - Drain spot Ø 50mm
- - Abflussplatz Ø 50 mm
- ⊠ - Panel - option
- ⊠ - Möglichkeit - Schürze

INSTALLATION RECOMMENDATION
MONTAGEEMPFEHLUNG

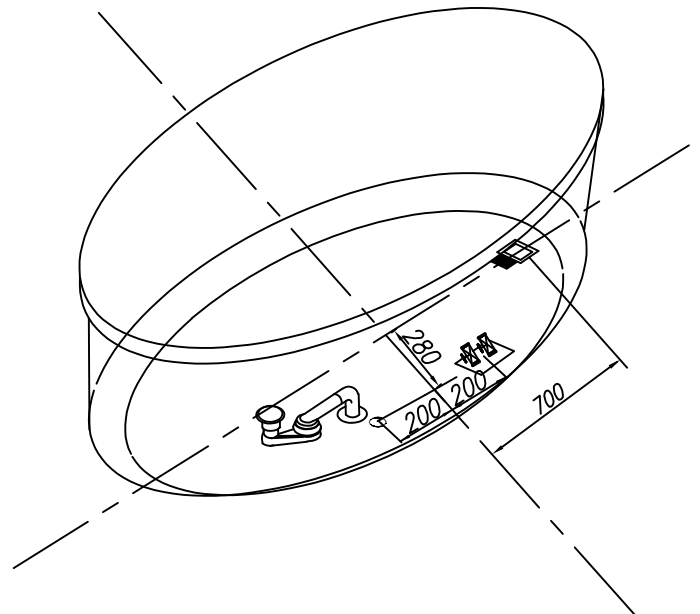

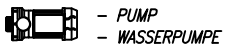

- PUMP
- WASSERPUMPE



- WATER JETS
- WASSERDÜSEN



- AIR CONTROLLER
- LUFTREGLER

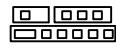

- ELECTRONIC SWITCHES
- ELEKTROSCHALTER



- FIXTURE AND SHOWER HANDLE
- WASSERHAHN UND DUSCHE



- BLOWER
- LUFTPUMPE



- AIR JET
- LUFTDÜSE



- PNEUMATIC SWITCH
- PNEUMATIKSCHALTER



- LIGHT OR CHROMOTHERAPY
- LICHT- ODER CHROMOTHERAPIE



- MICROJET SWITCH
- SCHALTER FÜR MIKRODÜSEN

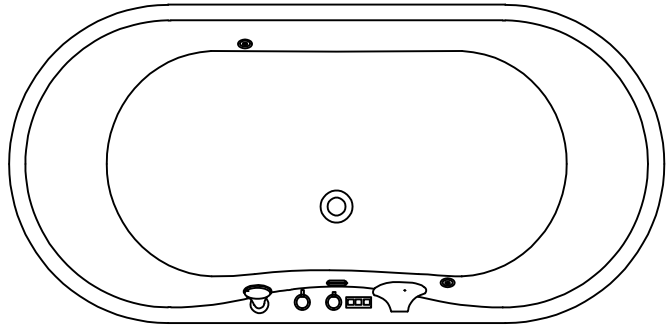
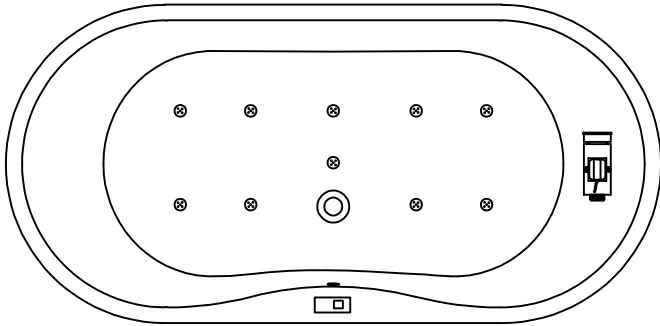

AIR MASSAGE SYSTEM

- BLOWER P=800W
- ELECTRONIC SWITCH
- 10 AIR JETS

LUFT MASSAGESYSTEM

- LUFTPUMPE P = 800 W
- ELEKTROSCHALTER
- 10 LUFTDÜSEN

- OPTION FIXTURE AND SHOWER HANDLE - MÖGLICHKEIT WASSERHAHN UND DUSCHE

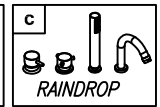
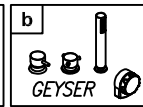
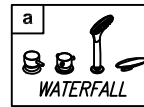
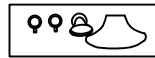

- OPTION CHROMOTHERAPY

- MÖGLICHKEIT CHROMOTHERAPIE

